

NOBO

Panel Heaters



WWW.HRV.CO.NZ | 0800 478 123





GLEN DIMPLEX

The World Leaders in Electric Heating

Nobo is part of the Glen Dimplex Group, the world's largest electric heating business. With design and production facilities across UK, Norway, France, Germany and greater Europe, we draw on a wealth of expertise and heritage. In fact the world's very first electric heater was produced by one of our brands in 1895. It is from this wide portfolio that Nobo Australia selects the ideal range for Australian homes.



DESIGNED IN NORWAY, MADE IN EUROPE

Scandinavian minimalist style

Scandinavian design is world famous for combining clean and timeless designs with user friendly functionality. Nobo shares this same design ethos with this latest range of panel heaters. By concealing the heat outlet vents behind the front panel, the seamless heater removes visual clutter and blends in against your wall. It's also only 5.5cm thick,

meaning it won't protrude unnecessarily and get bumped into. In Scandinavian style, the heater is built to withstand harsh winters that can plummet to as low as -40°C.

Installing Nobo will add style, comfort, efficiency and value to your home.



WALL MOUNTABLE OR PORTABLE

Wall installation is easy, no electricians are required and it only takes minutes. Alternatively, castors can be used if you want the freedom to move it between rooms. For safety, this heater is fitted with a tilt switch to stop operation if it is knocked over.



SILENT PERFORMANCE

Completely silent operation means the heaters are ideal for bedrooms. You'll have no fans, clicking mechanical thermostats or moving parts stopping you and your family from getting a peaceful rest. Install a Nobo Panel Heater with the confidence of healthier heating for your family. The fan free technology does not circulate dust or allergens, which may reduce air quality.





ULTRA ACCURATE THERMOSTAT

Set your desired temperature and know that your heater will stick to it and keep your home comfortable. With an electronic thermostat that fluctuates by only 0.1°C, you'll be getting the most accurate thermostat on the market.



SAVE YOUR ENERGY AND MONEY

Independent testing shows Nobo is 16% more efficient than similarly priced competitor panels*. This could equate to a saving of \$86 in heating costs each year** and over the lifespan of the heater, you could make back its initial cost. The heater also saves you power when not in use. On standby mode, the heater uses only 0.5 watts, compared to the 30 watts used in some other heaters. Nobo heaters are the more efficient, sustainable choice.

*based on independent testing of 2kW models of Nobo vs similarly priced competitor.

**Based on medium/high usage across winter using a 2kW heater at an average power price of 28c/kWh.



DESIGNED FOR DURABILITY

The Nobo range has been designed with a long-lasting aluminium element for superior durability.

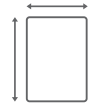

MINIMAL CLEARANCES

Nobo's clever design means it can be installed almost anywhere, including behind furniture, where other heaters may not work effectively.

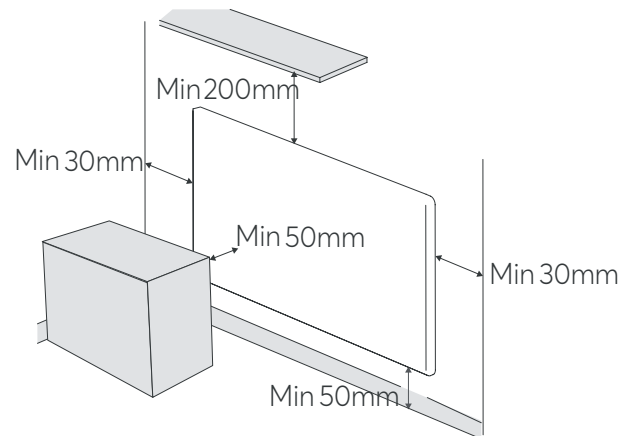

IP24 RATED

Nobo panel heaters are suitable for all locations, and approved for use in bathrooms with an IP24 splash proof rating. This design feature means that the appliance has the ability to be easily and safely installed into most household applications.





THE TIMER WITH A DIFFERENCE

You don't just have to settle for your timer to turn your heater on or off. The optional timer also allows you to set two different temperatures for different times of the day. For example, in your hallway, a higher temperature during the day (as you regularly pass through it) but a lower temperature during the night (just to take the chill off).

The effect of this is lower electricity bills as you only use power when you need it. You can programme settings for every day, individual days or weekend vs weekdays. Plus it comes with a child lock feature to ensure children don't change the settings or temperatures you have set.



WI-FI ENABLED via Capa Connect App

Experience the true comfort with the Capa Connect's Wi-Fi-enabled feature. By reducing the temperature or use of the heating during periods when you are asleep or away, you can save energy without compromising your comfort.

It's never been simpler to monitor your energy consumption – you can organise your heaters into zones for ease of control and create weekly schedules that'll suit your lifestyle, Capa Connect automatically keeps your devices up-to-date via Wi-Fi connectivity, ensuring consistent, optimal performance for your home heating system.



ADAPTIVE START

Adaptive start allows the heater to learn what time it needs to start heating, so that the room is at the set temperature by the time of the programmed setting. For example, if you program your heater for 20°C at 6am, it will start heating up before 6am so that by 6am, the room will be exactly 20°C!

The reason behind it is that many factors impact on room heat up times (e.g. size of the room and insulation), and initially the heater may start too early or too late. However, with the Adaptive Start, it will learn and recalibrate itself over several days, optimising itself to the best time to start heating.



DUAL HEAT

The Nobo Panel Heaters are designed to heat the room using both convection and radiant heat. This dual heating ensures quick, effective and efficient heating.

With concealed air vents, the heater draws in cool air, passing it over the aluminium element to naturally create convection heat. This heat is gently distributed through the room via the full width air vent at the top of the unit. The aluminium element within Nobo evenly heats the front panel, this heat then radiates throughout the room.

This radiant heat warms surfaces and objects around the unit maintaining the heat near the floor where it is required. Without the use of fans or mechanical moving parts, Nobo ensures efficient heating, with all energy used converted directly into heat.

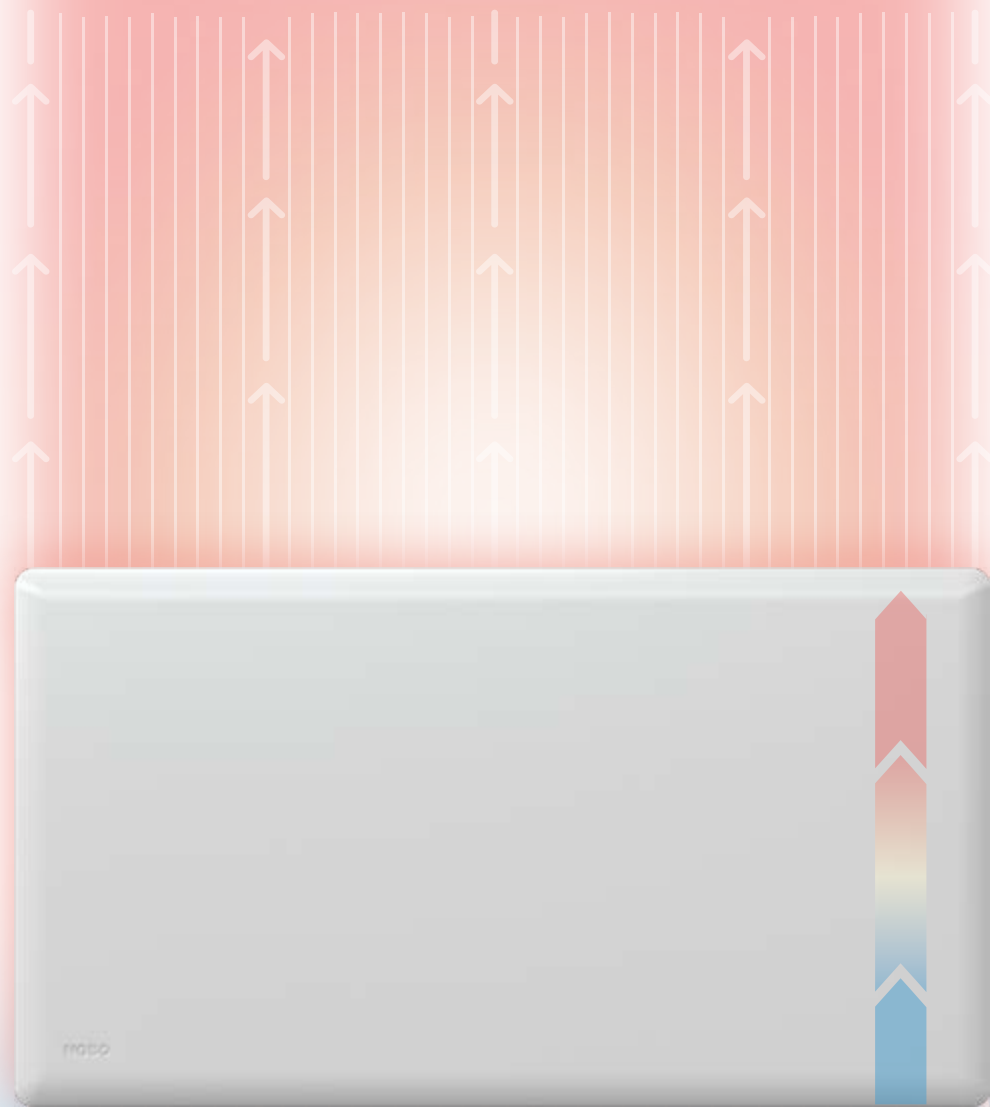



QUALITY AND SAFETY FOR ALL

The child friendly choice

Nobo panel heaters feature 14% lower surface temperatures* and by not exposing heat outlets on the front of the heater, it makes it harder for young ones to insert their fingers or any other objects. A child lock timer also means that curious kids cannot change any of the settings,** and with a super accurate thermostat, Nobo ensures stable temperatures to make sure your children sleep as sound as possible throughout the night.



LIMITED LIFETIME WARRANTY

As a sign of our commitment to quality, all Nobo Panel Heaters are covered under a LIMITED LIFETIME WARRANTY. We warrant our Nobo appliances to be free from defects in material or workmanship under normal domestic use and service.

At Nobo we are proud of the way we honour our warranties so you can rest assured that this product will provide years of reliable, energy efficient comfort to you and your home.

*based on independent testing of 2kW models of Nobo vs similarly priced competitor.

**Only with timer models

THE NOBO ADVANTAGE

There are many reasons why Nobo stands out from other panel heaters, we call this the Nobo Advantage



Norwegian design



Fast warm up



Quality and safety for all



Eco design approved



Wi-Fi Enabled



Concealed air vents to remove visual clutter



0.5W

Standby power consumption less than 0.5W



Precise electronic thermostat



Overheat safety cut-out



Adaptive Start



Save energy and money



Weekly timer included



Limited lifetime warranty



Quick installation



Castors for portability



IP24 Splash proof



Silent performance

SIZING OPTIONS

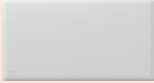
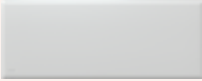
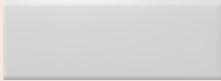
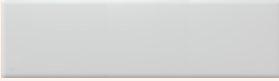
	PRODUCT CODE	WATTAGE (KW)	DIMENSIONS (MM)	WEIGHT	ROOM SIZE	RUNNING COST
	NTL4R10-FS40	1	725W x 400H x 55D	4.7kg	10m ² - small to medium sized bedrooms and bathrooms	14c
	NTL4R15-FS40	1.5	1025W x 400H x 55D	5.8kg	15m ² - medium to large bedrooms and lounges	21c
	NTL4R20-FS40	2	1125W x 400H x 55D	7.6kg	20m ² - large sized bedrooms, bathrooms and lounges	28c
	NTL4R24-FS40	2.4	1425W x 400H x 55D	8kg	24m ² - large sized bedrooms, bathrooms and lounges	34c

The width of the Nobo panel heaters ensure better heat distribution. By allowing more air to circulate through the elements and across surfaces, Nobo heats your room more evenly*. The guide above also gives you an indication on the size of heater you will need.

*Based on independent testing of 2kW models of Nobo vs similarly priced competitor.

Running costs and sizing guidelines are approximates only and may vary depending on various factors including ceiling height, furnishings, draughts and other variables. Electrical authority tariffs may vary, please refer to your electricity bill for accurate costs.

Assuming the panel heater has been correctly sized for the application, the thermostat will ensure that the unit is energised on average 50% of the operating time. The estimated running costs have been calculated based on an electricity tariff of 28c per kW/hour

Please note heating capacity will vary for each home depending on the individual application. Factors such as tiles, bricks and stairwells may alter the performance of each unit.

NOBO HEATING MANAGEMENT

Introducing Capa Connect, your go-to app for seamless heating management in the palm of your hand. With Capa Connect, effortlessly control multiple heating products using a single, user-friendly interface. Share access with family members and manage user permissions for ultimate control of your home's heating environment

The effortless heating app
that puts your comfort first



STAY CONNECTED, STAY IN CONTROL



Why Capa Connect?

- **Control** Control multiple heating products in a single app
- **User Access** Share access with others in your home or remove those who no longer need it.
- **Lock/Unlock** Secure your device by locking or unlocking controls to prevent unauthorized temperature changes.
- **Schedule** Design a personalized heating plan for maximum comfort and energy savings.
- **Manual Override** Swiftly bypass your schedule to conserve energy when departing home unexpectedly or to enjoy extra coziness if you return sooner than usual.
- **Sites & Zone** Organize your devices into sites and zones, such as "Bedrooms," to manage them more efficiently and create unique schedules.
- **Updates** Keep your device up-to-date automatically with Wi-Fi connectivity, ensuring optimal performance.

GETTING STARTED ON CAPA CONNECT

To create an account, download the Capa Connect app by searching for it in the Android or Apple app store, or by scanning the QR code on your compatible product's box.

After installing the app, open it and tap the 'Sign up/Sign in' button. You'll see a Welcome page where you can sign up using your email or phone number. Pick your preferred option and follow the instructions on the screen.

[How to create a Capa Connect account](#) (Video)

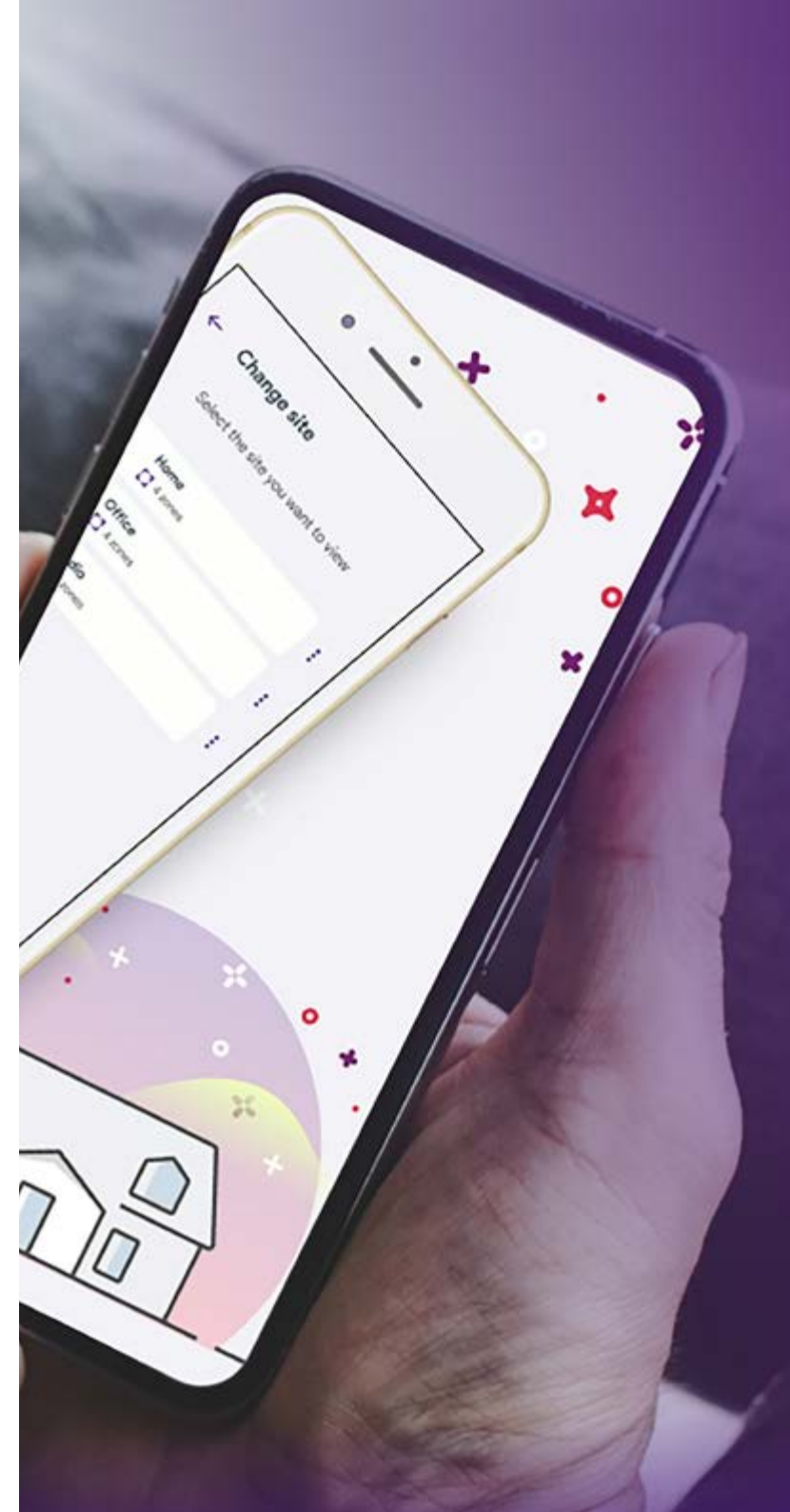



Experience the true comfort with Nobo heater's innovative heating app.

[How to add a Nobo heater to Capa Connect](#) (Video)



How HRV makes it easy and affordable



Choosing, buying and owning an HRV product should be a breeze – so we've worked hard to make sure it is!

For a drier, warmer, healthier home

PROFESSIONAL INSTALLATION

Your HRV installation team is trained to give you a smooth installation experience and a tidy finished result.

EXPERT SERVICING

Your HRV product is designed to give you many years of trouble-free operation. Regular servicing is key to that, so we stand by and service everything we sell.



REFER A FRIEND

Refer a new customer to HRV and get \$200 cash! Plus your friend will get a \$200 discount!*

*Terms and conditions apply. Eligible on a HRV ventilation system, ducted heat pump or a HRV hot water heat pump purchase.

CUSTOMER CARE ON CALL

Just call 0800 478 123 to connect with one of our super-friendly, experienced team. They love to help!

GET PEACE OF MIND WITH HRV

We take your trust seriously. So, everything we sell and install at HRV is backed by a comprehensive warranty (5 years for our HRV ventilation systems and accessories). If anything goes wrong during the warranty period, get in touch and we'll take care of it. Visit hrv.co.nz/warranty for more information.

PAYMENT OPTIONS AVAILABLE

HRV offer payment options with Q Card and Gem Interest Free to transform your home health. Visit hrv.co.nz/finance to find out more.



YOUR IN-HOME EXPERT

NAME

PHONE



[HRV.CO.NZ](http://hrv.co.nz)

0800 478 123